

VROC[®] initium one plus



The Workhorse for Viscosity
Fingerprinting
Automatic Viscometer/Rheometer



RheoSense

Simply Precise[®]

VROC[®] initium one plus is the leading automatic viscometer that measures true viscosity with the highest accuracy and repeatability. Its superior resolution is revolutionizing characterization of Newtonian and non-Newtonian samples



Absolute Viscosity



Sample Recovery & Retrieval



Viscosity Fingerprinting

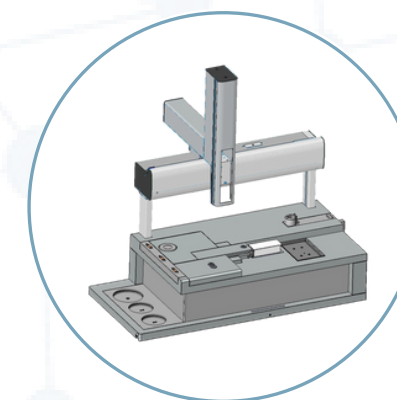

Fully Automated



Self Cleaning

Listed on US Pharmacopeia 914
www.rheosense.com/technology

Viscometer/Rheometer

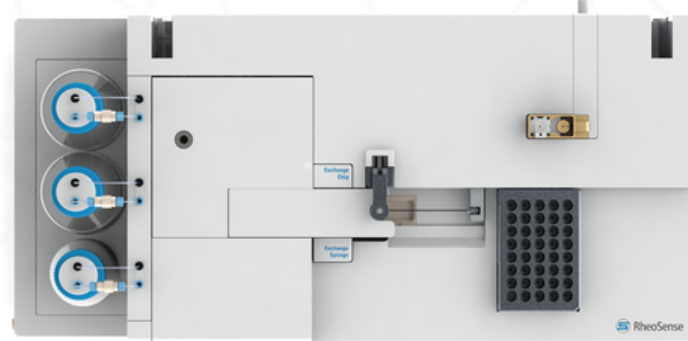

- Sample volume as low as 26 μL
- Viscosity Ranges: 0.3 – 1,000 mPa-s (with autosampler)
- 0.3 - 3,000 mPa-s (with manual syringe)
- Shear Rate Range 40 – 140,000 1/s
- Temperature Range 4 - 70°C
- Repeatability: 0.5% of reading
- Accuracy: 2% of reading
- Up to 4 samples per hour
- Standard 96 Well Plate or 40 Vial Rack
- Sample storage temperature control from 4- 40 ° C

*Acceptable solvent bottle sizes: 250 mL, 500 mL and 1 Liter.

Intelligent Formulation - Work Smart, Not Hard

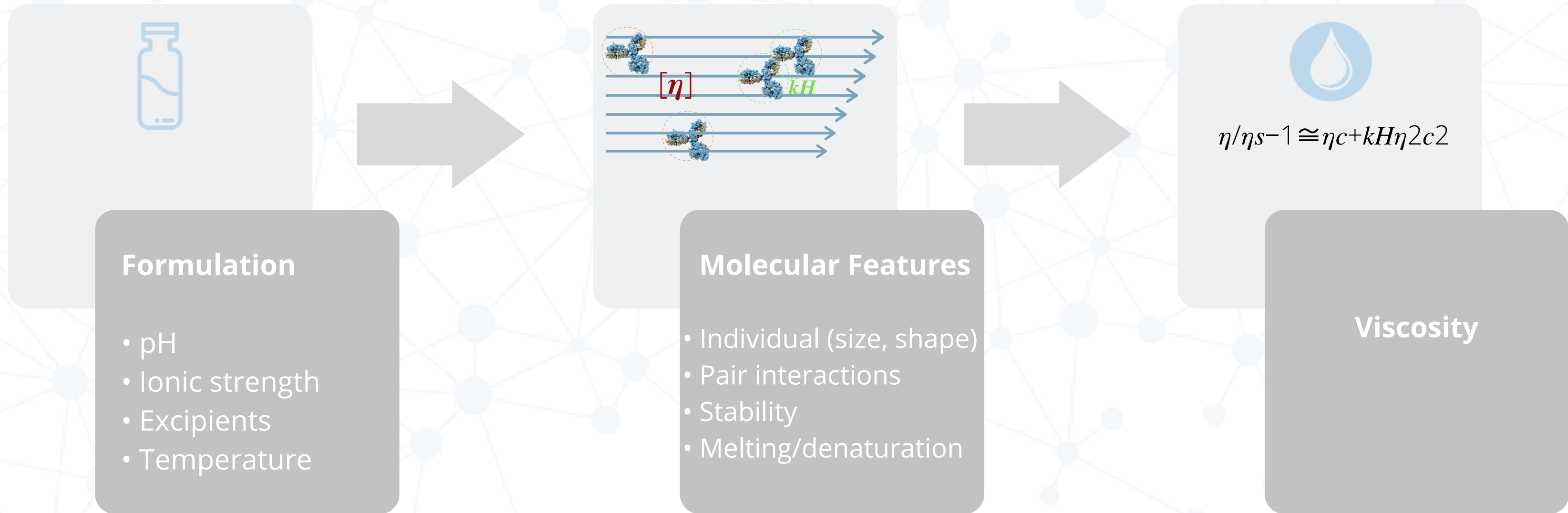

Understand how formulation impacts molecular scale behavior by measuring viscosity.

VROC[®] initium one plus Applications

 Engine Oils

 Standard Oils

 NIST Traceable Mineral Oils

 ASTM Standards

 Inkjet Inks

 Conductive/ Graphene Inks

 Electrolyte Solutions

 Skincare (serums)

 Fragrances

 Cannabis Oils

 Volatile Chemicals

 Food & Beverage

 Intrinsic Viscosity

 Automation

 Formulation

 Protein Screening

 Antibody Therapeutics

 Drug Delivery

 RNA Therapeutics

 Hydrodynamic Radius

 Whole Blood/Blood Plasma & Serum

 Enzymatic Reaction Kinetics

 Molecular Weight & Size

 Solubility

 Protein Stability

 Cell Culture

 Ophthalmic Solutions

 Viscosity-Injectability

Specifications

Power: AC 110 ~ 220 V
50/60 Hz, 150 Watts

Width: 715 mm

Length: 373mm

Height: 193 mm (without autosampler)
724 mm (with autosampler)

Weight: 14 kg (without autosampler)
22 kg (with autosampler)

CE and UL Certified

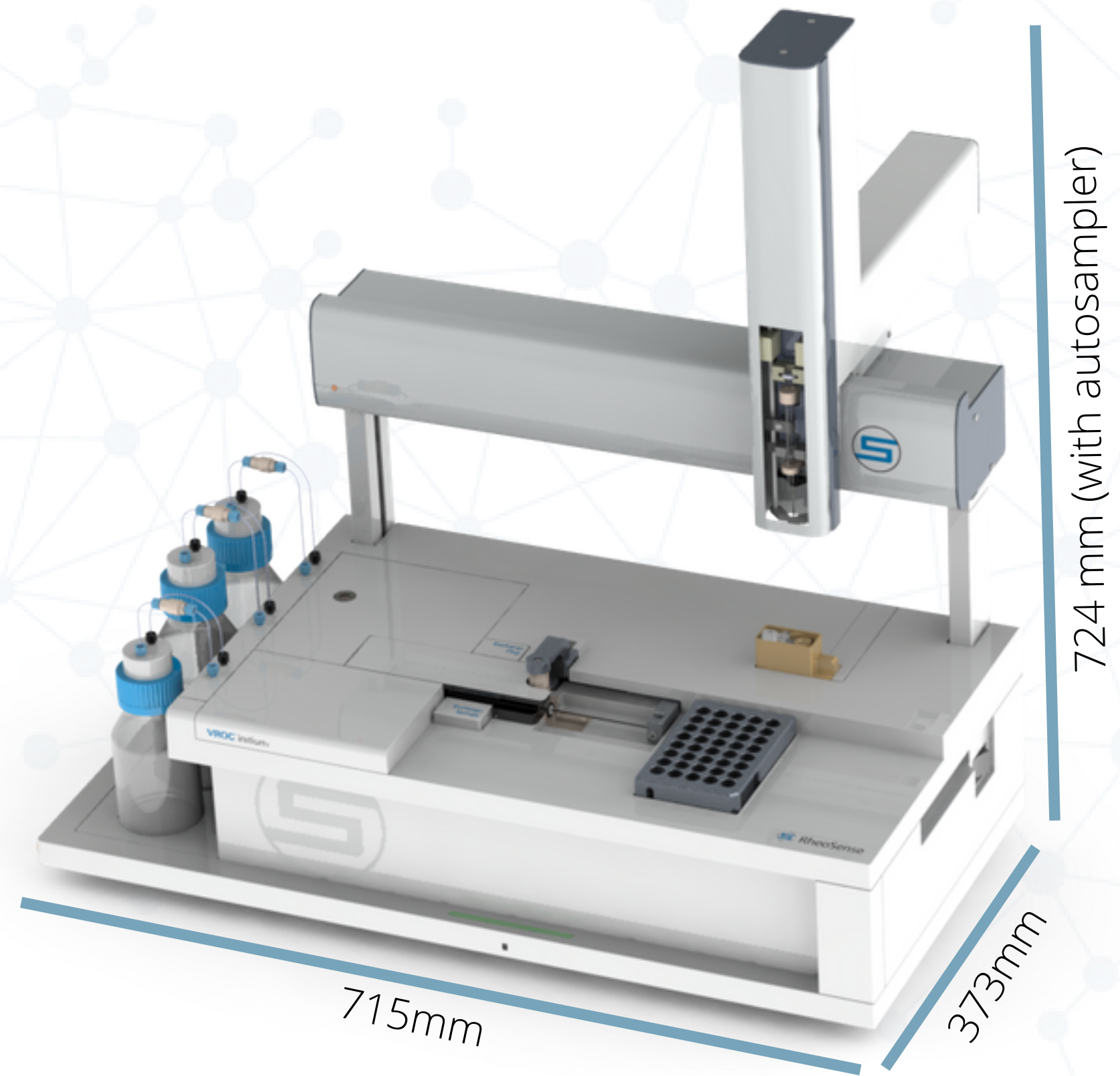

Clariti - Simplifying Your Data Analysis



RheoSense Clariti enables complete user versatility.

Clariti's advanced capabilities are leading the way in:

- Data Processing, Analysis to Report Generation
- Predictive Injectability Analysis
- Intrinsic Viscosity
- Hydrodynamic Radius and Pair Interactions
- Custom Report Generation
- So much more!

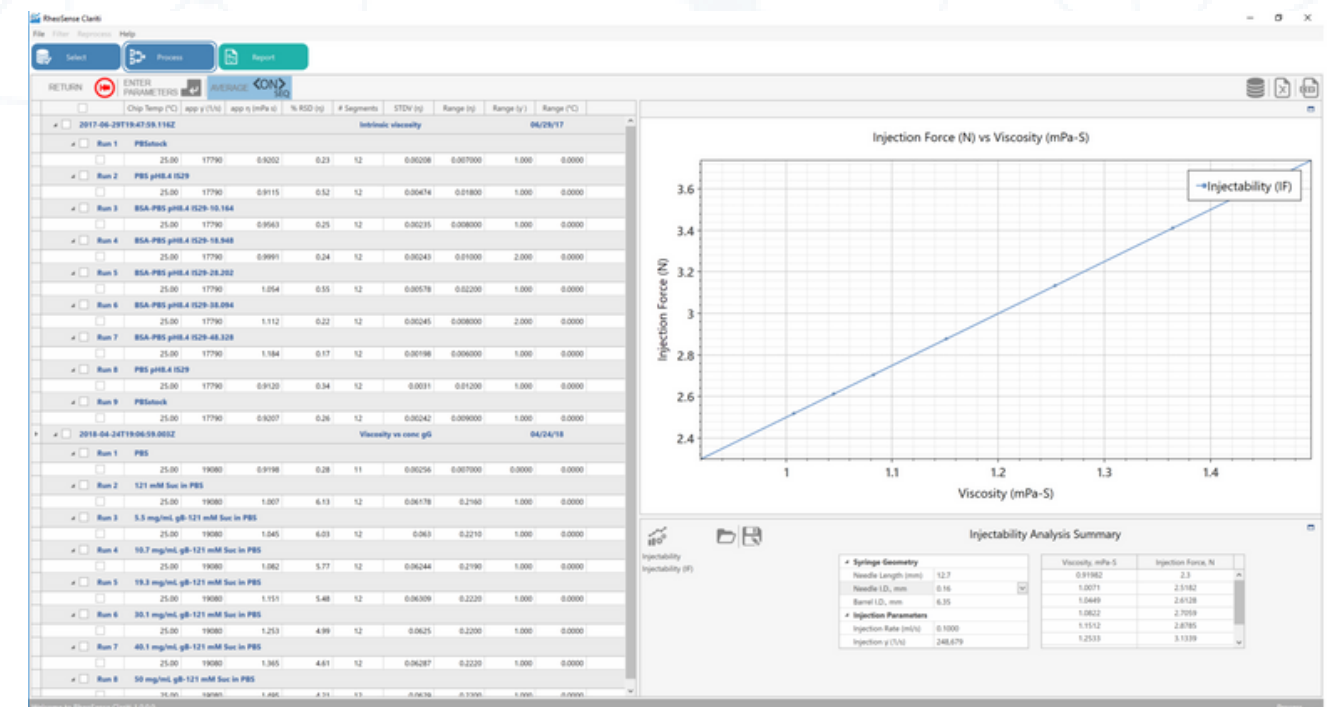
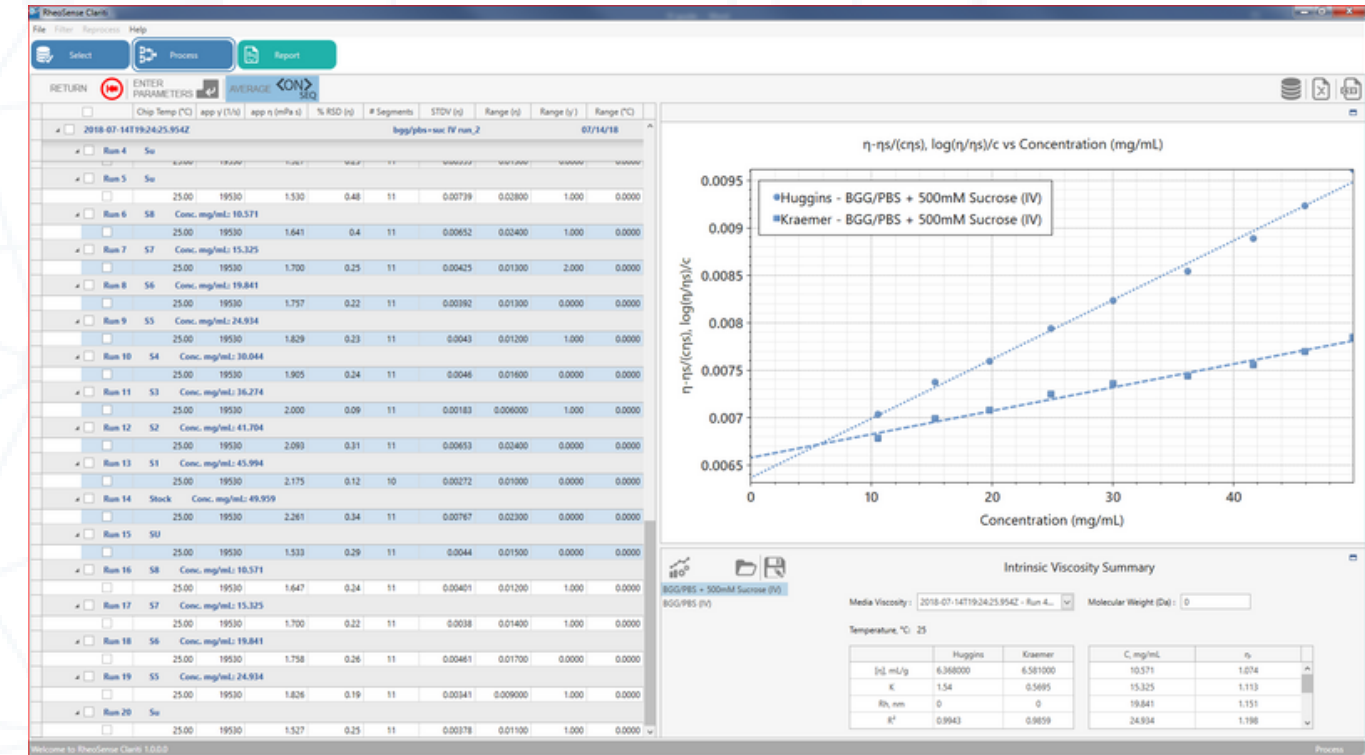



RheoSense

Simply Precise®

RheoSense is a global high-tech company based in Bay Area, California. Our innovative viscometers feature patented Viscometer/Rheometer-on-a-Chip (VROC®) technology. Utilizing state-of-the-art MEMS and microfluidic breakthroughs that redefined the viscometry industry, our instruments offer the smallest sample volume per measurement coupled with exceptional ease-of-use and accuracy.

 /company/rheosense

 /rheosense

 /rheosense

 blog.rheosense.com

 /rheosense

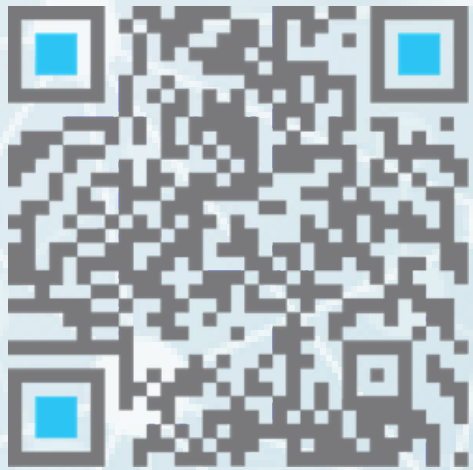

www.rheosense.com